

SUMMER REVIEW



Name: _____

Language Arts

I Can Write My ABCs

Directions : Color the picture in the box. Trace the uppercase and lowercase letters.

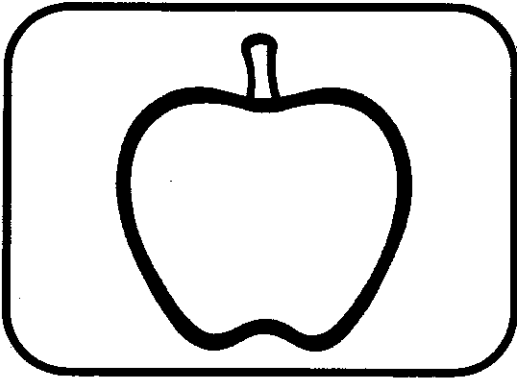

A A A A

a a a a a

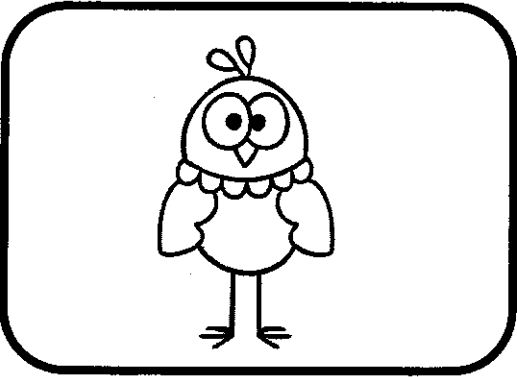

B B B B B

b b b b b

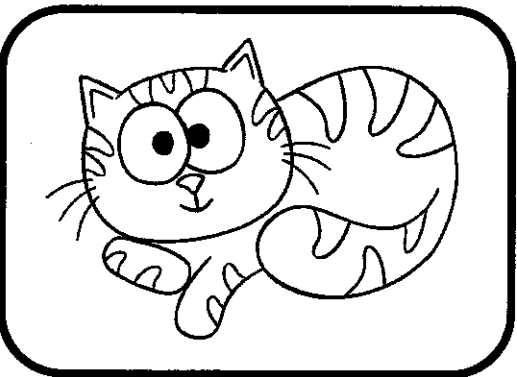

C C C C

c c c c c

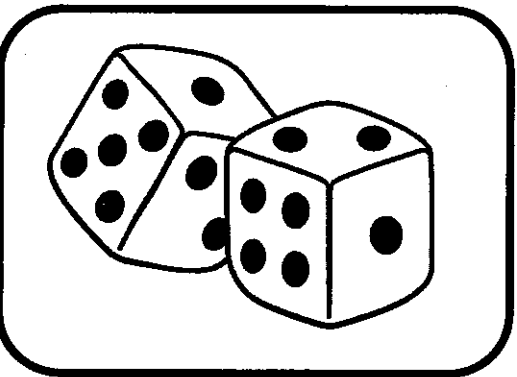

D D D D

d d d d d

Name: _____

Language Arts

I Can Write My ABCs

Directions : Color the picture in the box. Trace the uppercase and lowercase letters.

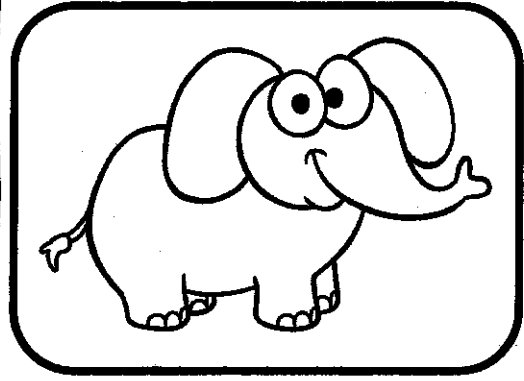

E E E E E

e e e e e

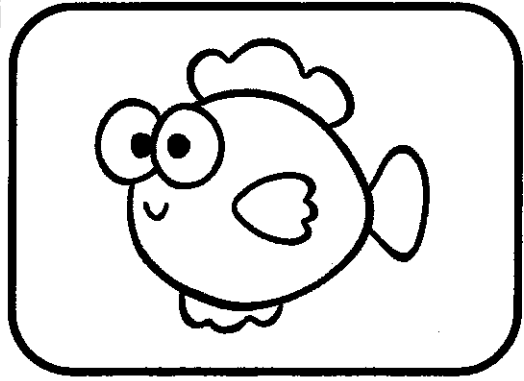

F F F F F

f f f f f

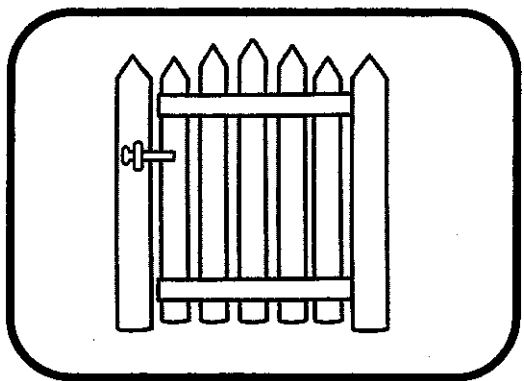

O O O O O

o o o o o

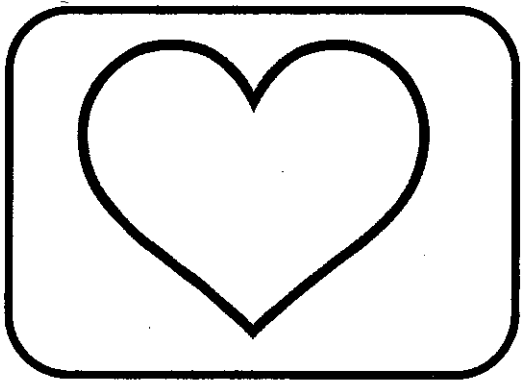

H H H H H

h h h h h

Name: _____

Language Arts

I Can Write My ABCs

Directions : Color the picture in the box. Trace the uppercase and lowercase letters.

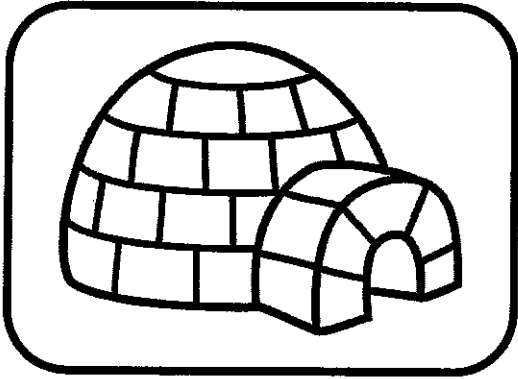

I I I I I

i i i i i

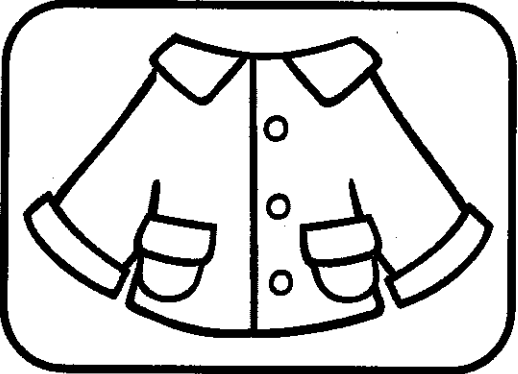

J J J J

j j j j j

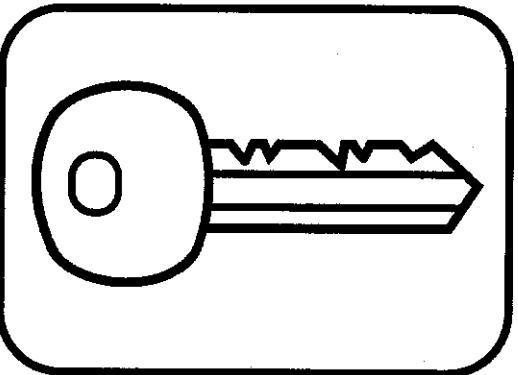

K K K K

k k k k

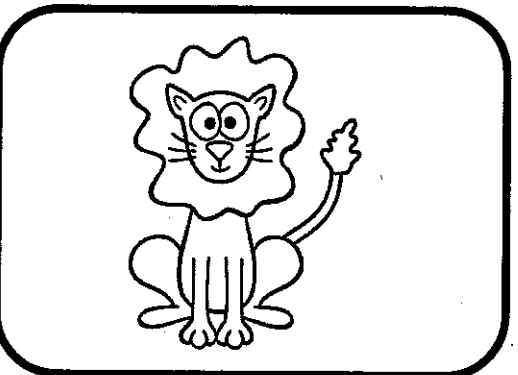

L L L L

l l l l

Name: _____ Language Arts

I Can Write My ABCs

Directions : Color the picture in the box. Trace the uppercase and lowercase letters.



M M M M

m m m m

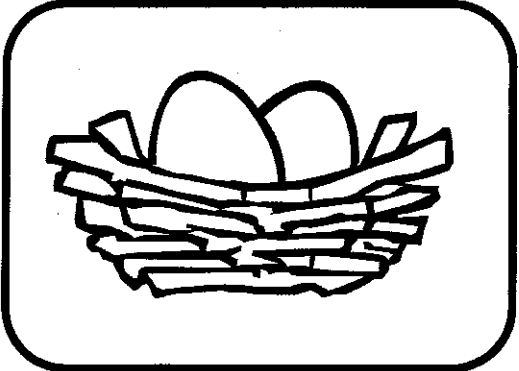

N N N N

n n n n

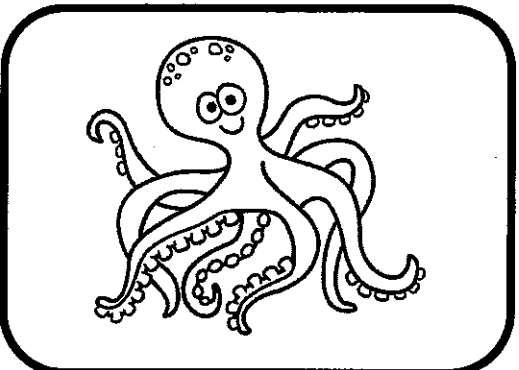

O O O O

o o o o

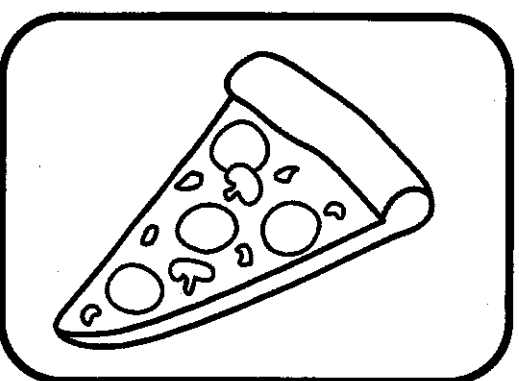

P P P P

p p p p

Name: _____

Language Arts

I Can Write My ABCs

Directions : Color the picture in the box. Trace the uppercase and lowercase letters.

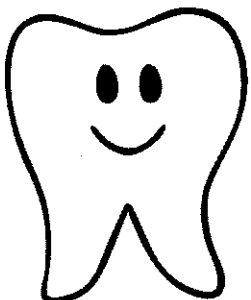
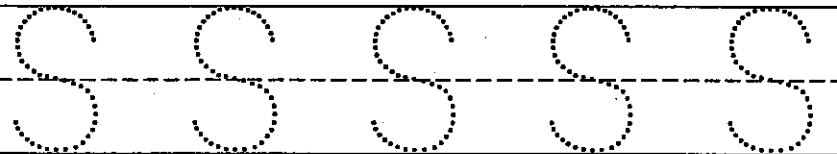
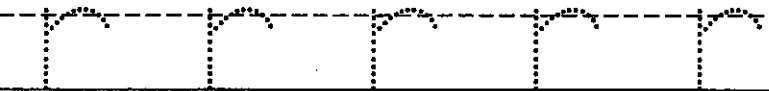
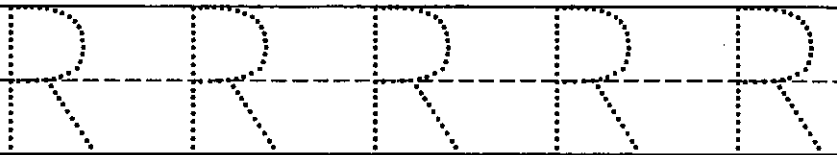
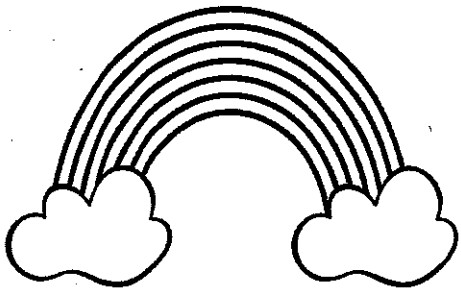
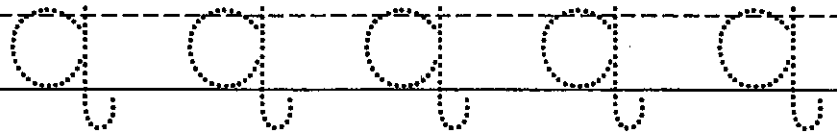
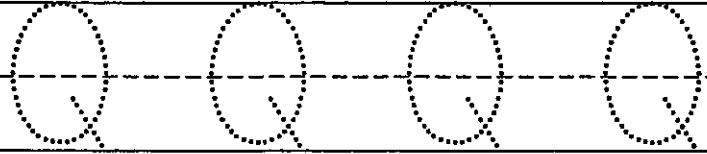
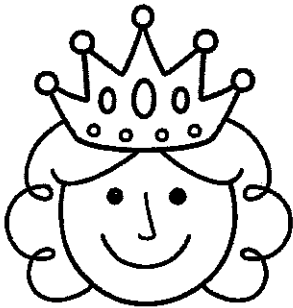

Name: _____ Language Arts

I Can Write My ABCs

Directions : Color the picture in the box. Trace the uppercase and lowercase letters.

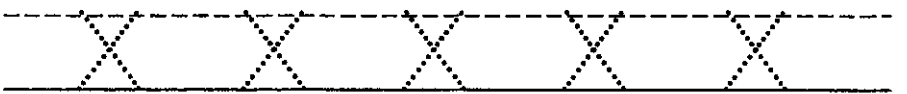
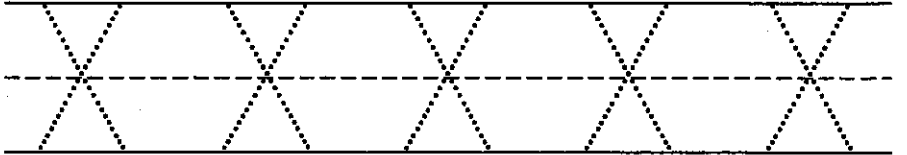
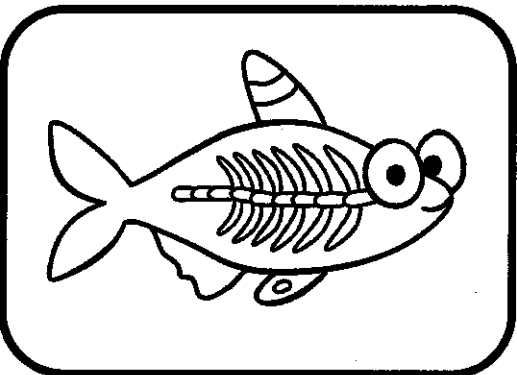
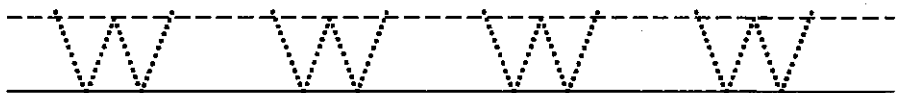
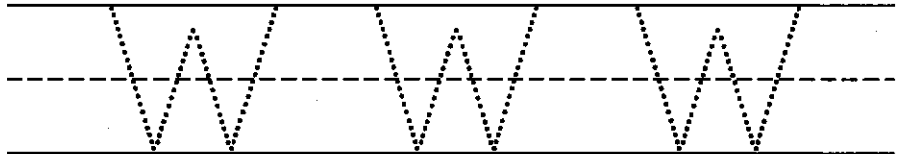
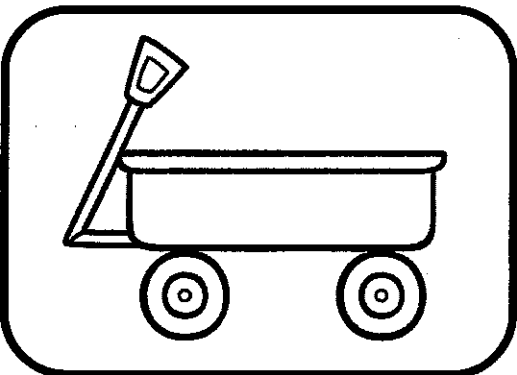
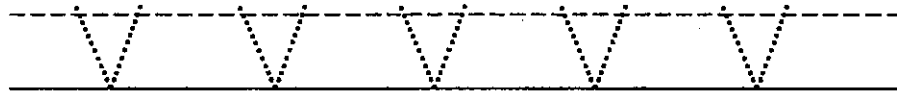
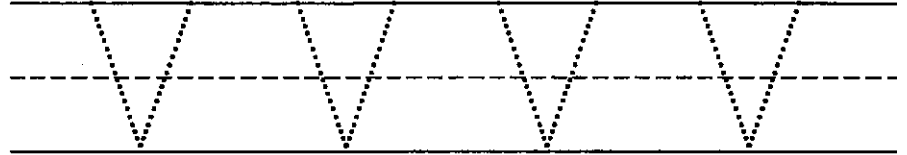
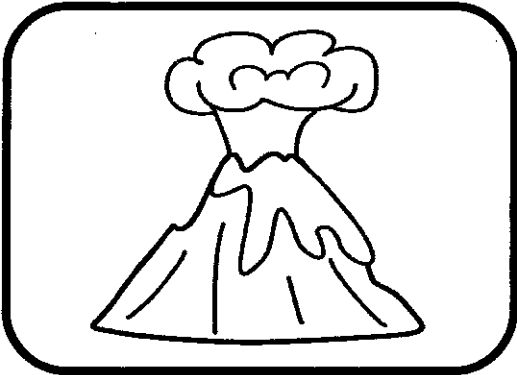
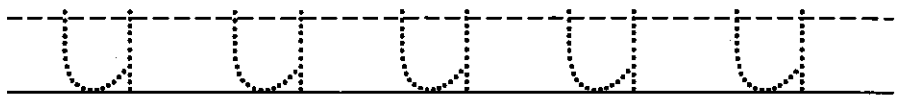
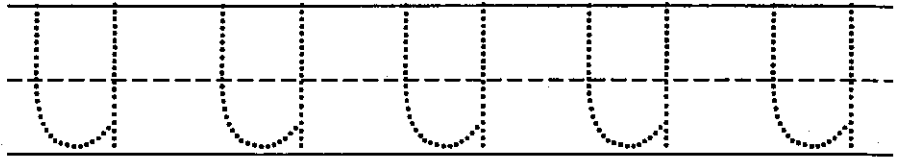
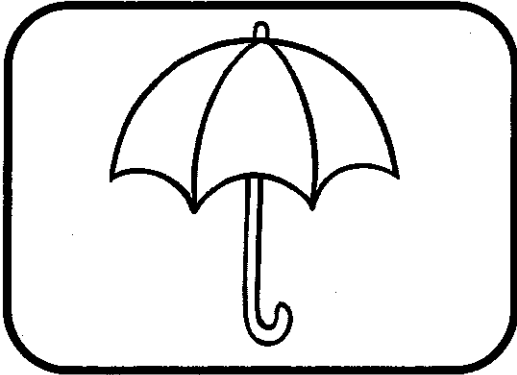

Name: _____ Language Arts

I Can Write My ABCs

Directions : Color the picture in the box. Trace the uppercase and lowercase letters.

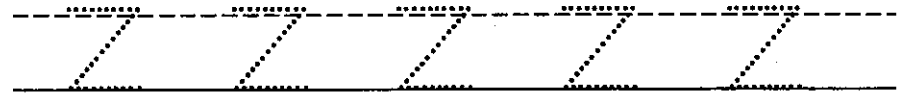
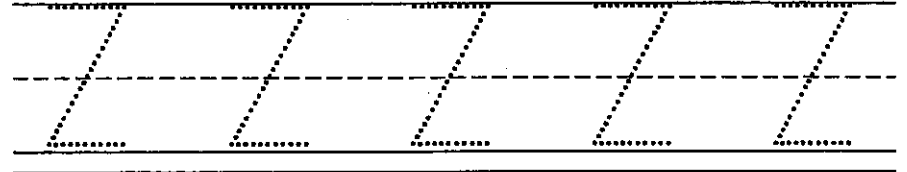
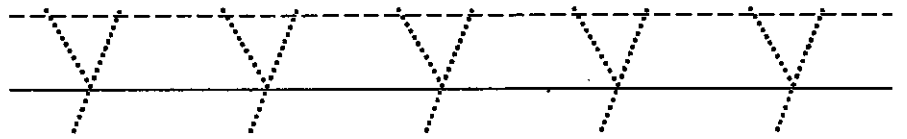
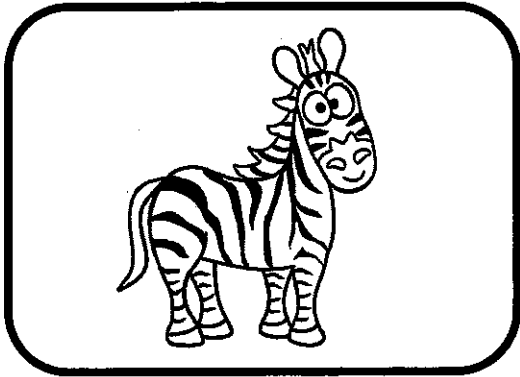
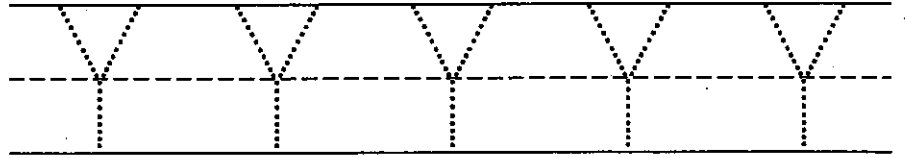
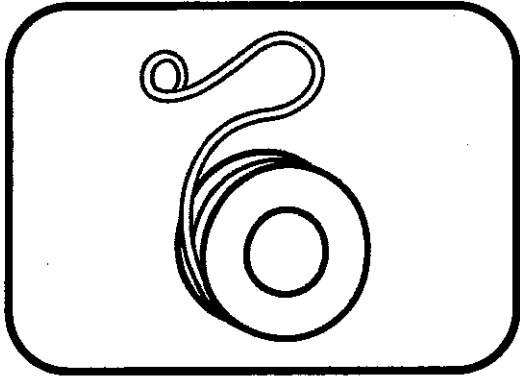

Name: _____ Language Arts

Lowercase Match

Directions : Look at the uppercase letter and draw a line to the lowercase letter.

Z

L

B

S

R

b

r

s

z

l

Name: _____ Language Arts

Lowercase Match

Directions: Look at the uppercase letter and draw a line to the lowercase letter.

C

q

Q

h

Y

w

H

y

W

c

Name: _____ Language Arts

Lowercase Match

Directions: Look at the uppercase letter and draw a line to the lowercase letter.

N

X

A

I

K

a

n

k

x

i

Name: _____ Language Arts

Lowercase Match

Directions : Look at the uppercase letter and draw a line to the lowercase letter.

U

D

M

p

G

d

p

g

u

m

Name: _____ Language Arts

I Start With Letter...

Directions: Color the pictures. Draw a line from the picture to the letter that it begins with.

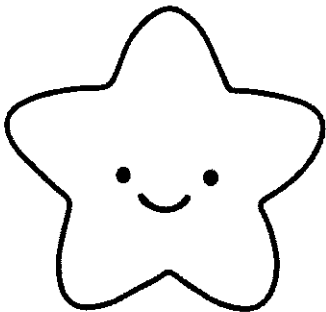
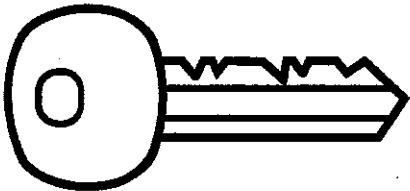
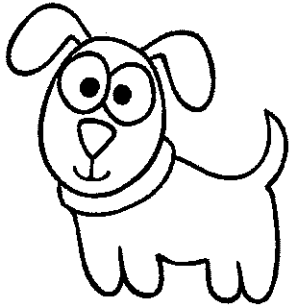
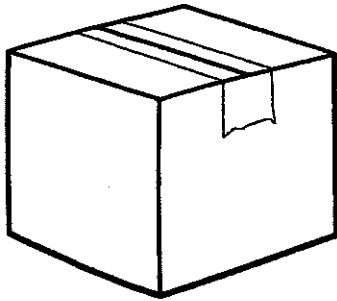
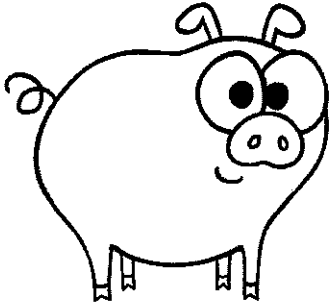

K

D

S

P

B

Name: _____ Language Arts

What Do I Start With?

Directions: Color the pictures. Look at each picture and circle the sound it starts with.

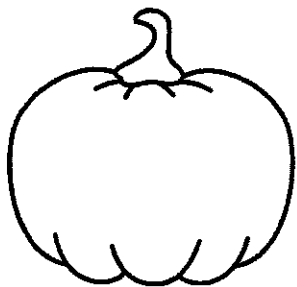

p g r

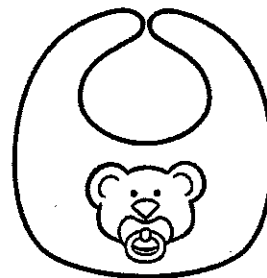

l w b



b c v



h j e

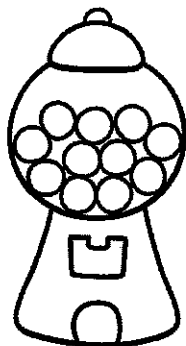

u w g

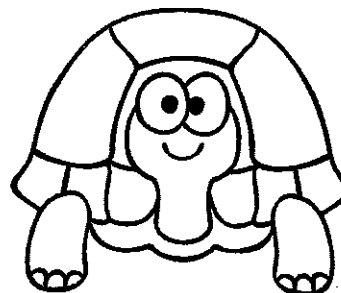

k t q

Name: _____

Language Arts

How Do I Start?

Directions: Color the pictures. Look at each picture and write the beginning sound.

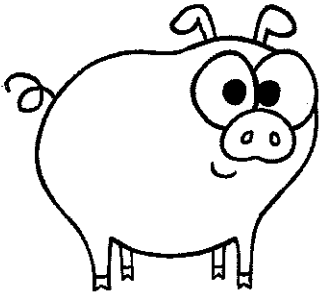

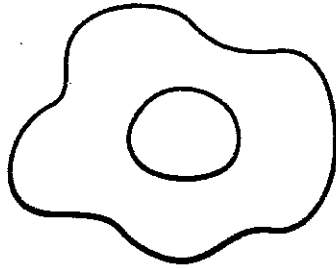



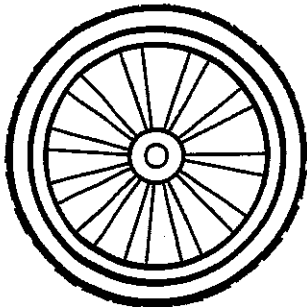

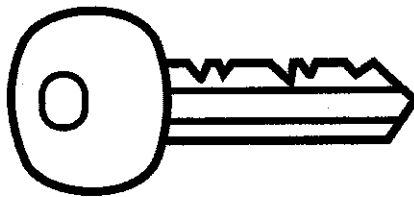

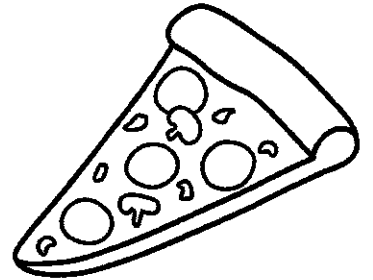



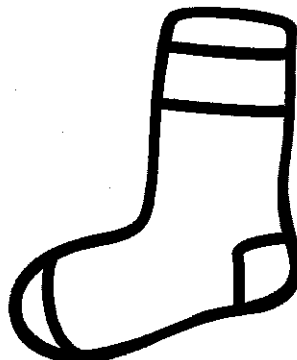

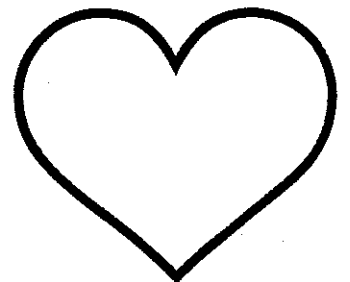

Name: _____ Language Arts

Beginning Sounds

Directions: Look at each picture and find out what the beginning sound is. Write the beginning sound in the black space. Color the picture.

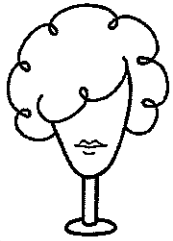

_____ ig



_____ at

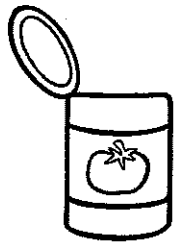

_____ an

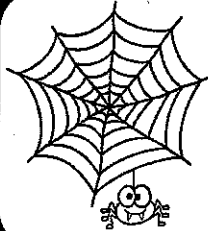

_____ eb

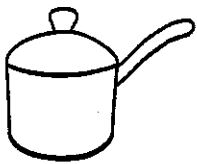

_____ ot



_____ ip



_____ ug

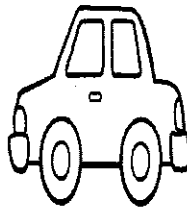

_____ ar

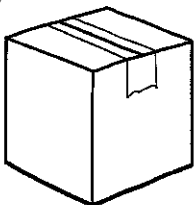

_____ ox



_____ eg

Name: _____ Language Arts

Word Match

Directions: Draw a line from the picture on the left to the correct written word on the right.

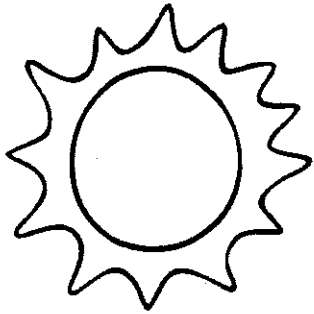

pig

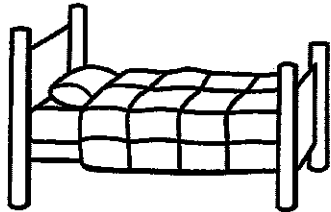

sun

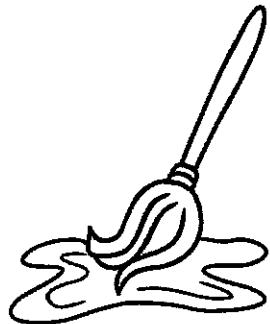

cat

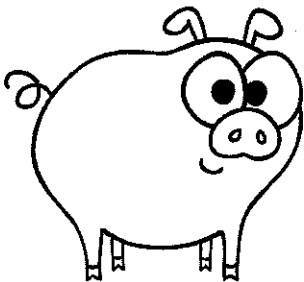

bed

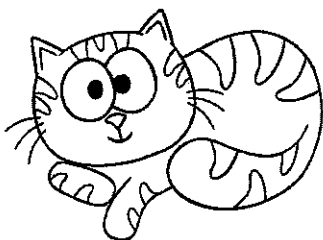

mop

Name: _____ Language Arts

Rhyming Words

Directions: Draw a line from the picture on the left to the rhyming picture on the right.

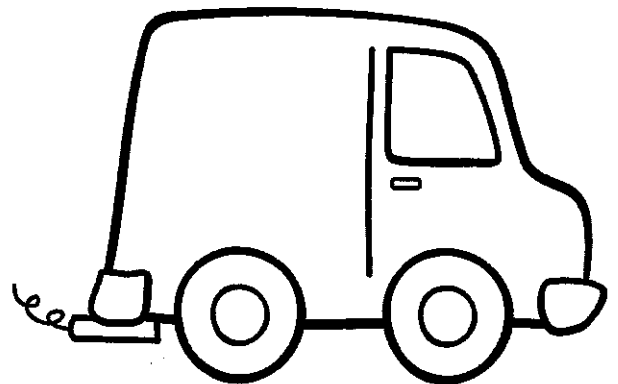
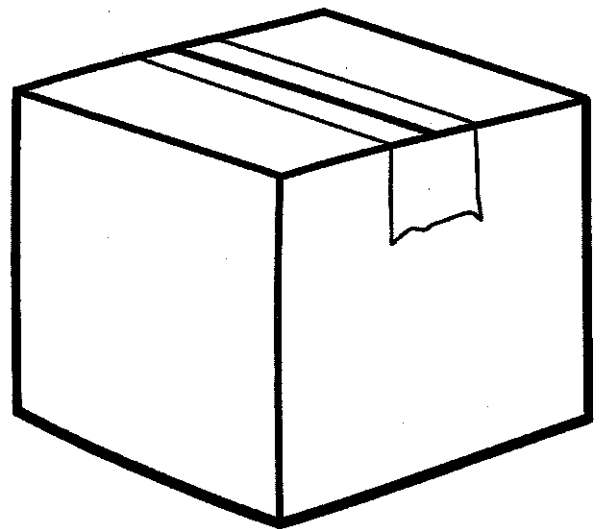
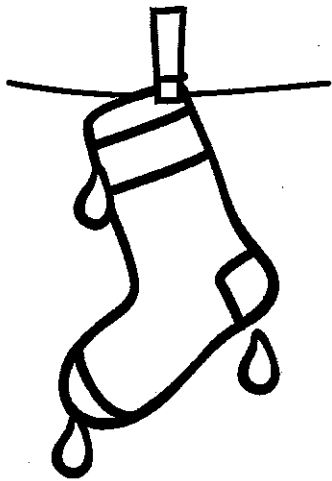
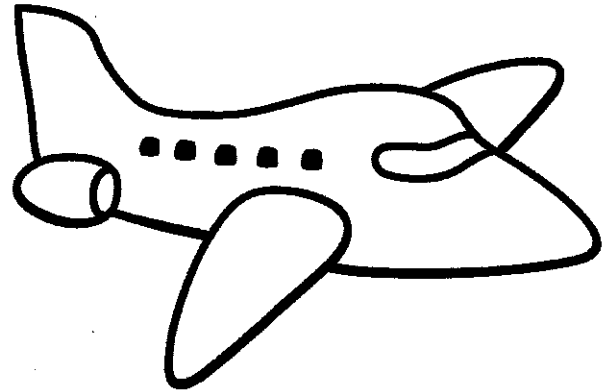
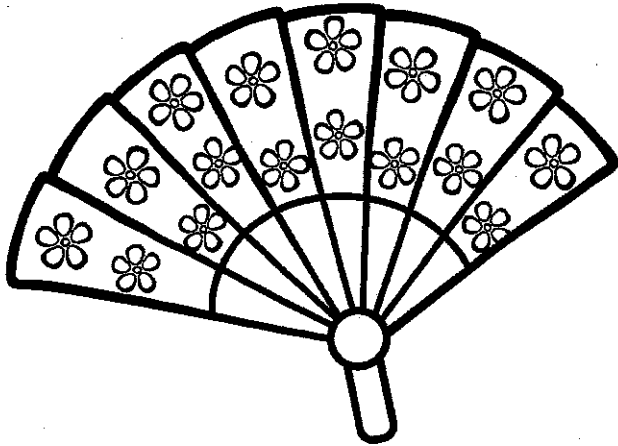

Name: _____

Language Arts

Find the Rhyme

Directions: Draw a line from the picture on the left to the rhyming picture on the right.

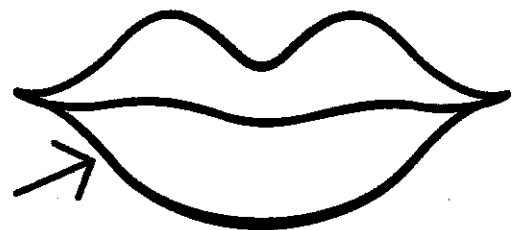
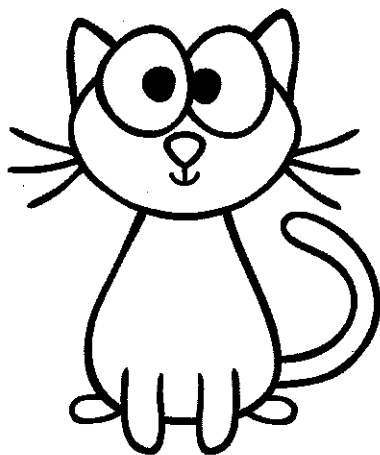
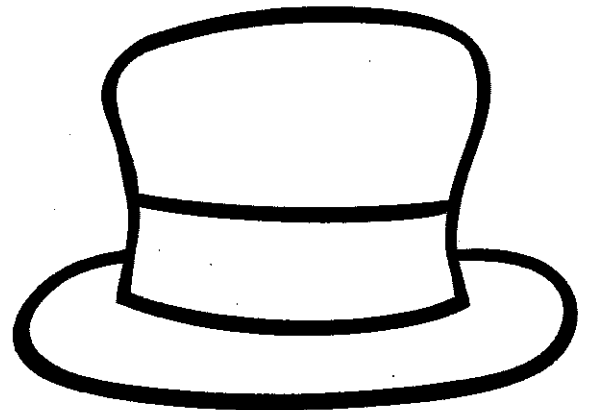
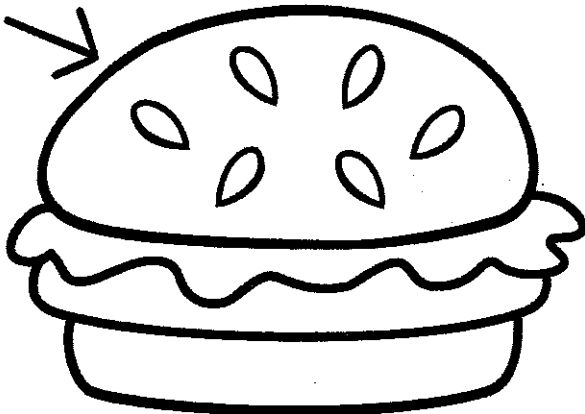
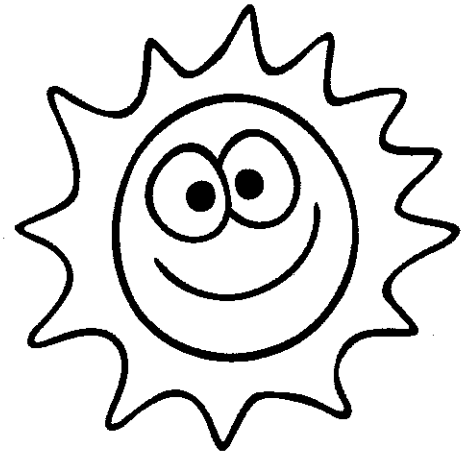
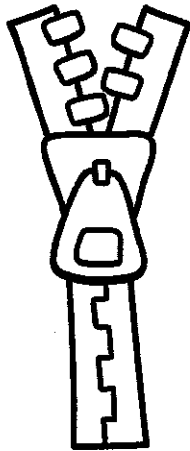

Name _____

Read	Write	Make
is	<hr/> <hr/> <hr/>	
me	<hr/> <hr/> <hr/>	
a	<hr/> <hr/> <hr/>	
the	<hr/> <hr/> <hr/>	
see	<hr/> <hr/> <hr/>	

t	a	s	i	e	e
e	h	s	e	m	

Name _____

Read	Write	Make
at	<hr/> <hr/> <hr/>	
can	<hr/> <hr/> <hr/>	
I	<hr/> <hr/> <hr/>	
go	<hr/> <hr/> <hr/>	
am	<hr/> <hr/> <hr/>	

m	l	c	a	g
o	n	t	a	a

Name _____

the



Read it 3 times:

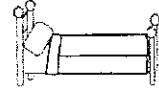

The dog is on the bed.



Write it:

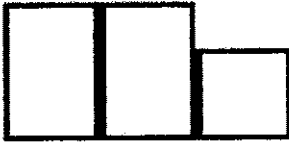



Find it:

the teh het the

th eth het the te

the hte he tet



Build it:

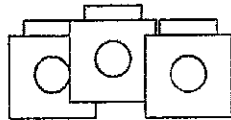

Draw it:



 dog is

on bed.

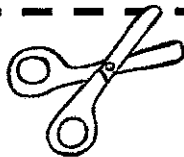
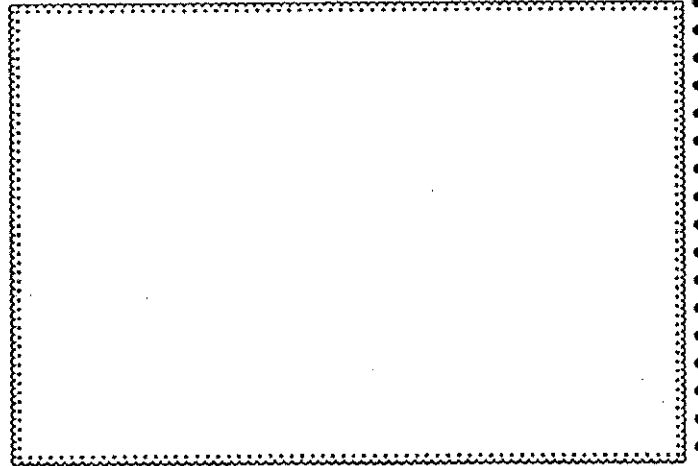

e h T h e t

NAME _____

DATE _____ - _____ - _____

My word
is
my



Say it:

my my my

Trace it.

my my my

Find my
and circle
it.

my a me this my
MY the **my** is this
m this a **mom** MY

Write it.

Cut letters and paste to make my.

□ □ □ □ □ □ □ □



m m M Y y y

NAME _____

DATE _____ - _____ - _____

My word
is
is



Say it:

is is is

Trace it.

is is is

Find is
and circle
it.

is this Is this my
MY is **IS** is this
IS this a **THE** MY

Write it.

_____	_____	_____
_____	_____	_____
_____	_____	_____

Cut letters and paste to make is.

--	--	--	--	--	--



s **S** **i** **I** **s** **i**

Name _____

big

Trace 

big big big

Write 

Color 

big big

Glue 

--	--	--

Cut 

i b g